

Mooney™ FlowMax™ HP

High-pressure reducing regulator
for natural gas



Mooney
a Baker Hughes business

Contents

4

Overview
Product Features
Applications

6

Pilot Ranges

7

Specifications



The Mooney FlowMax HP regulator is a high-pressure reducing regulator that offers a full Class 600 pressure rating, bubble tight shut-off at all pressure differentials and full capacity at very low differential pressures. This innovative Baker Hughes design compliments the Mooney *Flowgrid*[™] and FlowMax regulators. The FlowMax HP regulator maximizes capacity, speed of response, and accuracy up to 1%¹ while incorporating many of the same original maintenance and performance features for which the Flowgrid regulator is renowned.

Product Features

- Top-entry design for ease of maintenance
- High-Pressure Class 300 & Class 600 body and actuator ratings
- One actuator for all pressure control ranges
- Oversized balanced diaphragm for improved sensitivity
- Full port design for ultra high capacity
- Positive bubble tight shut-off at all pressure differentials
- Control range - 3 to 900 psig (0.21 to 62 bar)
- Full open differential - as low as 3 psig (0.21 bar)
- Quick acting two-path pilot control system
- Lightweight and compact design

Designed for a range of applications

- District regulator
- Monitor, first stage, or second stage regulator
- City gate station
- Industrial service regulator
- Boiler/burner fuel gas regulator
- High pressure/high volume applications



1. Accuracy is rated in accordance with EN 334 requirements

Bubble Tight Shut-Off



Designed for bubble tight shut-off at all pressures and full capacity at very low differential pressures

Pressure Reducing Valve

When the downstream pressure is greater than the set point of the pilot, the pilot is closed, resulting in equal pressure above and below the main diaphragm. With a balanced plug area slightly larger than the seat area, the resulting closing force, along with the force of the main spring, forces the plug against the seat.

With an increase in demand, the outlet pressure will begin to drop and decrease the pressure above the main diaphragm. The drop of the outlet pressure below the pilot set point will cause the pilot to open. As the pilot opens, pressure increases underneath the main diaphragm faster than pressure can bleed through the internal restrictor. The imbalance in pressure on the main diaphragm overcomes the spring force and the additional closing force from the plug, causing the plug to rise off the seat and satisfy the flow demand.

Once the flow demand is satisfied and the downstream pressure begins to increase, the pressure above the main diaphragm and in the pilot sense cavity rises.

This causes the pilot to close. The pressure below the main diaphragm bleeds through the internal restrictor until pressure equalizes above and below the main diaphragm. The forces of the main spring and the over-sized balancing diaphragm then close the plug on the seat.

Back Pressure Valve

In a back pressure relief application (BPV), the valve functions to maintain upstream pressure at the pilot set point. The sense line for the control pilot is located upstream of the regulator. The extra sense port on the actuator is plugged for BPV pilot configuration. The action of the pilot is the reverse of a pressure reducing pilot, such that the pilot opens when the upstream pressure increases above its set point. The pilot will close when the upstream pressure is less than its set point.

Noise Control Options

Where a regulator application is controlling a high pressure differential or high mass flow rate, noise may be a concern. In some cases, the resulting noise generated may be high enough to require control. The Mooney FlowMax HP has two *Lo-dB™* noise reduction options that can be specified. The Single Stage version provides noise attenuation of up to 20 dBA. For more severe applications a 2-Stage Lo-dB trim provides reductions up to 30 dBA. Both fit into the standard FlowMax HP without other modifications to allow field retrofit where required.

Open (modulating) Position

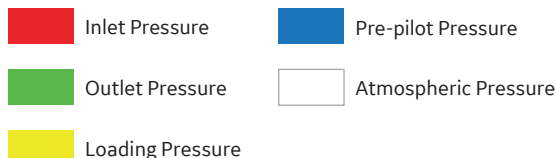
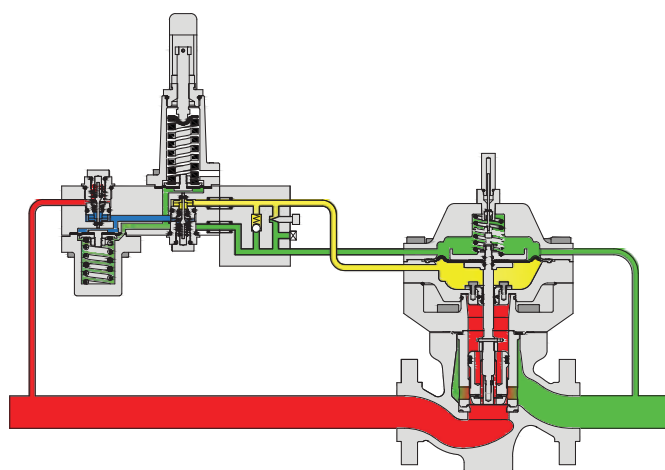



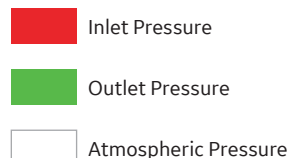
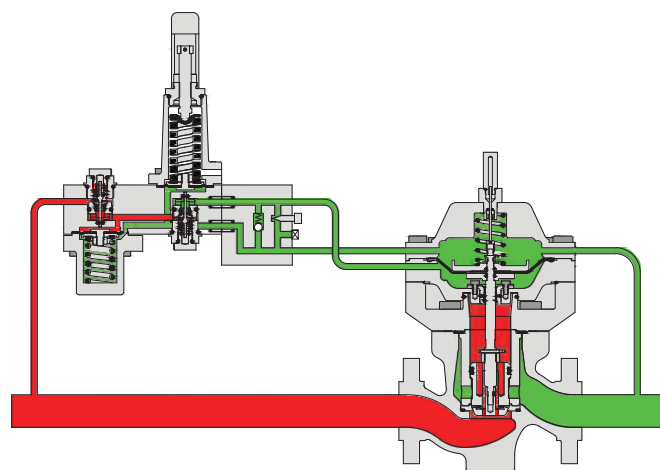





Closed Position



Mooney Series 22, 22H

The Mooney Series 22 Pilot is a stainless steel, modular design which provides multiple regulating systems; pressure relieving, back pressure, standby monitor, and working monitor mode for the Flowmax HP. The Series 22 Pilot must be paired with the Type 27 variable restrictor which provides adjustable system gain, stability, and response. The Type 27 variable restrictor features a built-in check valve to prevent damage to diaphragm if the regulator sees high back pressure.

	Spring Color	Series 22 pilot	Outlet Pressure Range
	Red	22	3-12 psig (0.21 - 0.83 bar)
	Silver	22	10-40 psig (0.69 - 2.8 bar)
	Blue	22	25-90 psig (1.7 - 6.2 bar)
	Purple	22	60-200 psig (4.1 - 13.8 bar)
	Black	22	100-260 psig (6.9 - 18 bar)
	White/Green	22	200-450 psig (13.8 - 31 bar)
	Black	22H	200-520 psig (13.8 - 37 bar)
	White/Green	22H	400-900 psig (28 - 62 bar)

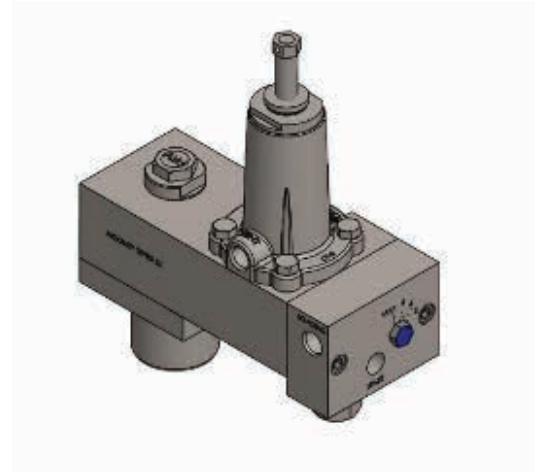

Simple in-line maintenance:

Modular construction allows for simplified in-line maintenance and repair. Diaphragm replacement requires only the removal of the top cover, without disturbing the pressure boundary seals or regulator internals. Internal trim can be accessed and replaced by removing alternate bolts on the actuator and lifting the actuator section off intact. All without the need to remove the pilot assemblies or remove the regulator from the piping, greatly reducing the time to repair and disruption to service.



Shown with optional Lo-dB trim

General Data & Specifications

Body Size	2" (DN 50)	3" (DN 80)	4" (DN 100)	6" (DN 150)
End Connection	CL 300 RF CL 600 RF	CL 300 RF CL 600 RF	CL 300 RF CL 600 RF	CL 300 RF CL 600 RF
Body Material	Steel	Steel	Steel	Steel
Maximum Inlet Pressure¹				
CL 300 RF ¹ CL 600 RF ¹	740 psig (51 bar) 1480 psig (102 bar)	740 psig (51 bar) 1480 psig (102 bar)	740 psig (51 bar) 1480 psig (102 bar)	740 psig (51 bar) 1480 psig (102 bar)
Maximum Outlet Pressure^{1,2}				
Maximum Outlet Pressure ^{1,2} Maximum Operating Differential ¹ Minimum Differential (fully open)	1480 psi (102 bar) 1480 psi (102 bar) 3 psig (0.21 bar)	1480 psi (102 bar) 1480 psi (102 bar) 4 psig (0.28 bar)	1480 psi (102 bar) 1480 psi (102 bar) 4 psig (0.28 bar)	1480 psi (102 bar) 1480 psi (102 bar) 4 psig (0.28 bar)
Maximum Casing Pressure				
CL 300 RF ¹ CL 600 RF ¹	740 psig (51 bar) 1480 psig (102 bar)	740 psig (51 bar) 1480 psig (102 bar)	740 psig (51 bar) 1480 psig (102 bar)	740 psig (51 bar) 1480 psig (102 bar)
Outlet Pressure Range				
Series 22 Pilot FEP-1500-CH Pilot ²	3-900 psig (0.21-62 bar) 800-1300 psig (55-90 bar)	3-900 psig (0.21-62 bar) 800-1300 psig (55-90 bar)	3-900 psig (0.21-62 bar) 800-1300 psig (55-90 bar)	3-900 psig (0.21-62 bar) 800-1300 psig (55-90 bar)
Maximum Operating Differential Pressure				
Main Valve Series 22 Pilot	1480 psid (102 bard) 1000 psid (69 bard) between loading pressure in pilot and sense pressure			
Temperature				
Operating Temperature Emergency Temperature	-20°F to 150°F (-29°C to 66°C) -40°F to 175°F (-40°C to 79°C)	-20°F to 150°F (-29°C to 66°C) -20°F to 150°F (-29°C to 66°C)	-20°F to 150°F (-29°C to 66°C) -20°F to 150°F (-29°C to 66°C)	-20°F to 150°F (-29°C to 66°C) -20°F to 150°F (-29°C to 66°C)

1. Do not exceed the pressure and temperature limits for the pressure class and body material as defined in ASME B16.34
2. Consult factory for outlet pressures (set pressure) above 900 psi (62 bar)

Specifications Overview

Size inches (mm)	End Connections	Orifice Size inches (mm)	Stock No.	Stock No. w/Indicator	Max Pressure psig (bar)	Min Differential psig (bar)	Face to Face inches (mm)	Valve Weight lbs. (kg)
2 (50)	CL 300 RFF	2 (50)	FM-14	FM-14T	740 (51)	3 (.21)	10.50 (267)	160 (73)
	CL 600 RFF		FM-18	FM-18T	1480 (102)	3 (.21)	11.25 (286)	163 (74)
3 (80)	CL 300 RFF	3 (80)	FM-15	FM-15T	740 (51)	4 (.28)	12.50 (317)	302 (136)
	CL 600 RFF		FM-19	FM-19T	1480 (102)	4 (.28)	13.25 (337)	308 (140)
4 (100)	CL 300 RFF	4 (100)	FM-16	FM-16T	740 (51)	4 (.28)	14.50 (368)	448 (203)
	CL 600 RFF		FM-20	FM-20T	1480 (102)	4 (.28)	15.50 (394)	469 (213)
6 (150)	CL 300 RFF	6 (150)	FM-17	FM-17T	740 (51)	4 (.28)	18.62 (473)	654 (297)
	CL 600 RFF		FM-21	FM-21T	1480 (102)	4 (.28)	20.00 (508)	705 (320)

Flow Coefficients & Constants

100% Capacity	2" (DN 50)	3" (DN 80)	4" (DN 100)	6" (DN 150)
Cg	2380	4970	7880	13720
C1	34	36	36	36
Cv	70	138	219	381

Direct Sales Office Locations

Australia

Brisbane
Phone: +61-7-3001-4319

Perth
Phone: +61-8-6595-7018

Melbourne
Phone: +61-3-8807-6002

Brazil

Phone: +55-19-2104-6900

China

Phone: +86-10-5738-8888

France

Courbevoie
Phone: +33-1-4904-9000

India

Mumbai
Phone: +91-22-8354790

New Delhi
Phone: +91-11-2-6164175

Italy

Phone: +39-081-7892-111

Japan

Tokyo
Phone: +81-03-6871-9008

Korea

Phone: +82-2-2274-0748

Malaysia

Phone: +60-3-2161-03228

Mexico

Phone: +52-55-3640-5060

Russia

Veliky Novgorod
Phone: +7-8162-55-7898

Moscow
Phone: +7-495-585-1276

Saudi Arabia

Phone: +966-3-341-0278

Singapore

Phone: +65-6861-6100

South Africa

Phone: +27-11-452-1550

South & Central America and the Caribbean

Phone: +55-12-2134-1201

Spain

Phone: +34-935-877-605

United Arab Emirates

Phone: +971-4-8991-777

United Kingdom

Phone: +44-7919-382-156

United States

Houston, Texas
Phone: +1-713-966-3600

Find the nearest local Channel Partner in your area:
valves.bakerhughes.com/contact-us

Tech Field Support & Warranty:

Phone: +1-866-827-5378
valvesupport@bakerhughes.com

valves.bakerhughes.com

Baker Hughes 